



# OPERATOR'S MANUAL FOR 12,000 RPM 3 in. (77 mm) Light Weight RANDOM ORBITAL SANDERS

<p><b>Declaration of conformity</b> DIXON ENTERPRISES, INC. 571 BIRCH STREET LAKE ELSINORE, CA 92530 declare on our sole responsibility that the products 3 in. LW Random Orbital Sanders (See "Product Configuration/Specifications" Table for particular Model) to which this declaration relates is in conformity with the following standard(s) or other normative document(s) EN ISO 15744:2008. Following the provisions of 89/392/EEC as amended by 91/368/EEC &amp; 93/44/EEC 93/68/EEC Directives and consolidating Directive 2006/42/EC</p>		
05.23.2013	<b>Meri Faria</b>	
Place and date of issue	Name	Signature or equivalent marking of authorized person
<p><b>Operator Instructions</b> Includes – Please Read and Comply, Proper Use of Tool, Warranty, Product Configuration and Specifications Table, Parts Page, Parts List, Work Stations, Putting the Tool Into Service, Operating Instructions and Compressor Layout, Back-Up Pads, Service Tools and Accessories, Overhaul Service Kit, Spare Part Kits, Service Instructions.</p>		<p><b>Important</b> Read these instructions carefully before installing, operating, servicing or repairing this tool. Keep these instructions in a safe accessible location.</p>
<p><b>Manufacturer/Supplier</b> DIXON ENTERPRISES, INC. 571 BIRCH STREET LAKE ELSINORE, CA 92530 Tel: 951-245-4200 Fax: 951-245-4299</p>		<p><b>Required Personal Safety Equipment</b> Safety Glasses      Breathing Masks Safety Gloves      Ear Protection</p>
<p><b>Recommended Airline Size - Minimum</b> 10 mm                      3/8 in</p>	<p><b>Recommended Maximum Hose Length</b> 8 meters                      25 feet</p>	<p><b>Air Pressure</b> Maximum Working Pressure    6.2 bar    90 psig Recommended Minimum            NA            NA</p>

## Please Read and Comply with:

- 1) General Industry Safety & Health Regulations, Part 1910, OSHA 2206, available from: Superintendent of Documents; Government Printing Office; Washington DC 20402
- 2) Safety Code for Portable Air Tools, ANSI B186.1 available from: American National Standards Institute, Inc.; 1430 Broadway; New York, New York 10018
- 3) State and Local Regulations.

## Proper Use of Tool

This sander is designed for sanding all types of materials i.e. metals, wood, stone, plastics, etc. using abrasive designed for this purpose. Do not use this sander for any other purpose than that specified without consulting the manufacturer or the manufacturer's authorized supplier.

Do not use back-up pads that have a working speed less than 12,000 RPM free speed. Never use back-up pads that have a weight and/or size different than the machine was specifically designed for.

## Warranty

All SurfPrep™ Random Orbital Sanders are warranted for defects in materials or workmanship for one year from the date of delivery to the user. Combined with the SurfPrep™ name, this Warranty expresses our total confidence in the superior quality, durability, and performance of the SurfPrep™ LP. To receive any expressed or implied warranty, tool must be repaired by an authorized SurfPrep™ Service Center. The "Service Instructions" section in this document is provided for use after completion of the warranty period. To receive warranty, tools must be operated under the conditions as described in the "Putting the Tools into Service" section of this document and be connected to an air supply system as shown in Figure 1. Tools that have been exposed to extreme conditions will be covered under warranty at the sole discretion of SurfPrep™

# Parts Page

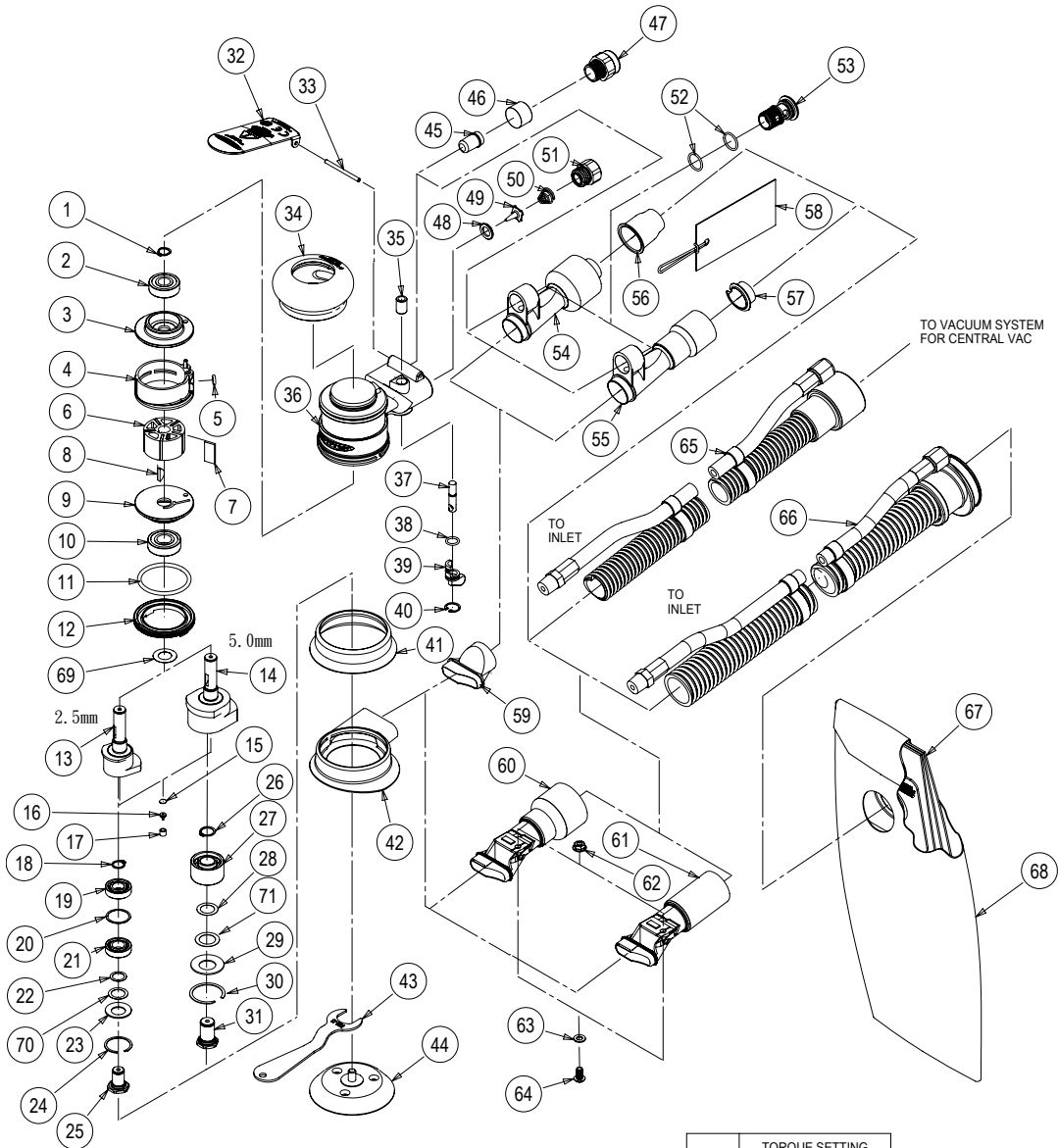

TO VACUUM SYSTEM  
FOR CENTRAL VAC

TO INLET

TO INLET

ITEM	TORQUE SETTING Nm (in.-lbs.)
12	6.2 - 7.3 (55 - 65)
47	1.8 - 2.3 (16 - 20)
51	6.8 - 8.1 (60 - 72)
53	4.0 - 5.4 (36 - 48)
64	3.4 - 3.9 (30 - 35)

# Parts List

Item	Part No.	Description	Qty.
1	SPA0040	EXTERNAL RETAINING RING	1
2	SPA0021	BEARING	1
3	SPB0017	REAR ENDPLATE	1
4	SPA0005	CYLINDER ASSEMBLY	1
5	SPA0042	O-RING	1
6	SPB0005	ROTOR	1
7	SPA0010	VANE	5
8	SPA0041	WOODRUFF KEY	1
9	SPB0016	FRONT ENDPLATE	1
10	SPA0019	BEARING	1
11	SPA0045	O-RING	1
12	SPA0001	LOCK RING	1
13	SPB0084	3 x 3/32 in. (2.5 mm) ORBIT SHAFT BALANCER	1
14	SPB0309	3 x 3/16 in. (5.0 mm) ORBIT SHAFT BALANCER	1
15	SPA0122	FILTER	1
16	SPA0121	DUCKBILL CHECK VALVE	1
17	SPA0120	VALVE RETAINER	1
18	SPA0107	RETAINING RING	1
19	SPA0162	BEARING	1
20	SPA0196	SPACER	1
21	SPA0161	BEARING	1
22	SPA0108	SHIM	1
23	SPA0126	BELLEVILLE WASHER	1
24	SPA0177	RETAINING RING	1
25	SPB0083	SPINDLE	1
26	SPA0090	RETAINING RING	1
27	SPA0938	DOUBLE ROW ANGULAR CONTACT BEARING	1
28	SPA0016	SPACER	1
29	SPA0017	BELLEVILLE WASHER	1
30	SPA0018	RETAINING RING	1
31	SPB0312	SPINDLE	1
32	SPA2872	THROTTLE LEVER 3/16 in. (5 mm) ORBIT 12,000 RPM ROS	1
33	SPA0031	LEVER SPRING PIN	1
34	SPA0241	2 1/2 in. (65 mm)GRIP	OPT
	SPA0242	2 3/4 in. (69 mm)GRIP	1
	SPA0243	3 in. 75 mm) GRIP	OPT
	SPA0015	VALVE SLEEVE	1
35	SPA0015	VALVE SLEEVE	1
36	SPA2878	HOUSING	1
37	SPA0008	VALVE STEM ASSEMBLY	1
38	SPA0043	O-RING	1
39	SPB0014	SPEED CONTROL	1
40	SPA0039	INTERNAL RETAINING RING	1
41	SPA2891	NON-VAC SHROUD (BLUE 2945C)	1
42	SPC0047	SuperVAC SKIRT - 3/32 in. (2.5 mm) ORBIT (BLACK)	1
	SPC0243	SuperVAC SKIRT - 3/16 in. (5 mm) ORBIT (BLACK)	1
43	SPA0146	17 mm WRENCH	1
44	N/A	1 Back-up Pad supplied with each tool (type determined by model)	1
45	SPA0062	INTERNAL MUFFLER	1
46	SPA0068	MUFFLER INSERT	1
47	SPA0166	MUFFLER HOUSING	1
48	SPA0009	VALVE SEAT	1
49	SPA0007	VALVE	1
50	SPA0014	VALVE SPRING	1
51	SPA0013	INLET BUSHING ASSEMBLY	1
52	SPA0044	O-RING	2
53	SPA0006	SGV RETAINER	1
54	SPA0410	ASSEMBLY FOR 1 in./28 mm HOSE SuperVAC SGV SWIVEL EXHAUST FITTING	1
55	SPA0409	ASSEMBLY FOR 3/4 in./19 mm HOSE SuperVAC SWIVEL EXHAUST FITTING	OPT
56	SPA0778	1 in./28 mm HOSE SEAL	1
57	SPA0854	3/4 in./19 mm HOSE SEAL	OPT
58	SPA0855	3/4 in./19 mm HOSE SEAL TAG W/INSTRUCTION	OPT
	SPA0935	1 in./28 mm HOSE SEAL TAG W/INSTRUCTION	1
59	SPC0108	SuperVAC SGV SKIRT/SHROUD ADAPTER	1
60	SPA0099	ROS SuperVAC™ CV 1 in./28 mm SWIVEL EXHAUST ASSEMBLY	OPT
61	SPA0205	ROS SuperVAC CV 3/4 in. SWIVEL EXHAUST ASSEMBLY	1
62	SPA0048	FLANGED NUT	1
63	SPA0047	WASHER	1
64	SPA0769	HEX SOCKET BUTTON HEAD MACHINE SCREW	1
65	SPA0300	Ø 3/4 in. VAC HOSE TO Ø 3/4 in. x 1 in./28 mm ADAPTER COUPLING AND AIRLINE ASSM	OPT
66	SPA0411	Ø 3/4 in. VAC HOSE TO DOUBLE BAG FITTING AND AIRLINE ASSY	OPT
	SPA0412	Ø 1 in. VAC HOSE TO DOUBLE BAG FITTING AND AIRLINE ASSY	1
67	SPC0109	VACUUM BAG INSERT	1
68	SPC0110	VACUUM BAG	1
69	SPA2541	FRONT BEARING DUST SHIELD	1
70	SPA2543	SPINDLE BEARING DUST SHIELD 3/32in. ORBIT	1
71	SPA2542	SPINDLE BEARING DUST SHIELD	1

# Product Configuration and Specifications: 12,000 RPM, 3 in. Light Weight Random Orbital Sander

Note: All Self Generated Vacuum machines use Ø 1 in. (Ø 28 mm) Vacuum Hose Fittings Standard. Ø ¾ in. (Ø 19 mm) is available. All Central Vacuum machines use Ø ¾ in. (Ø 19 mm) Vacuum Hose Fittings Standard. Ø 1 in. (Ø 28 mm) is available. All 3" machines are shrouded with 1/4-20 male pad attachment.

Orbit	Pad Face	Vac Type	Model No.	Product Net Weight Pound (kg)	Height inch (mm)	Length inch (mm)	Power HP (watts)	Air Consumption scfm (LPM)	*Noise Level dBA	**Vibration Level m/s <sup>2</sup>	**Uncertainty Factor2
3/32 in. (2.5 mm)	Vinyl	Non-Vacuum	SP031200	1.12 (0.51)	3.5 (88.0)	4.9 (124.3)	.28 (209)	17 (481)	80	2.0	1.0
		Central Vacuum	SP031234	1.26 (0.57)	3.5 (88.0)	7.3 (186.2)	.28 (209)	17 (481)	80	2.0	1.0
		Self-Gen Vacuum	SP031267	1.30 (0.59)	3.5 (88.0)	7.5 (190.1)	.28 (209)	17 (481)	84	2.6	1.3
	Hook	Non-Vacuum	SP031201	1.12 (0.51)	3.5 (90.0)	4.9 (124.3)	.28 (209)	17 (481)	80	2.0	1.0
		Central Vacuum	SP031235	1.26 (0.57)	3.5 (90.0)	7.3 (186.2)	.28 (209)	17 (481)	80	2.0	1.0
		Self-Gen Vacuum	SP031268	1.30 (0.59)	3.5 (90.0)	7.5 (190.1)	.28 (209)	17 (481)	84	2.6	1.3
3/16 in. (5.0 mm)	Vinyl	Non-Vacuum	SP031290	1.33 (0.60)	3.5 (89.0)	4.9 (124.3)	.28 (209)	17 (481)	74	2.7	1.4
		Central Vacuum	SP031311	1.47(0.66)	3.5 (89.0)	7.3 (186.2)	.28 (209)	17 (481)	76	2.3	1.2
		Self-Gen Vacuum	SP031331	1.51 (0.68)	3.5 (89.0)	7.5 (190.1)	.28 (209)	17 (481)	88	2.8	1.4
	Hook	Non-Vacuum	SP031291	1.33 (0.60)	3.6 (91.0)	4.9 (124.3)	.28 (209)	17 (481)	74	2.7	1.4
		Central Vacuum	SP031312	1.47(0.66)	3.6 (91.0)	7.3 (186.2)	.28 (209)	17 (481)	76	2.3	1.2
		Self-Gen Vacuum	SP031332	1.51 (0.68)	3.6 (91.0)	7.5 (190.1)	.28 (209)	17 (481)	88	2.8	1.4

The noise test is carried out in accordance with EN ISO 15744:2008 Measurement of noise emission from hand-held non-electric power tools. The vibration test is carried out in accordance with EN 28662-1. Hand-held portable power tools – Measurement of vibration at the handle. Part 1: General and EN 8662-8, 1997. Hand-held portable power tools – Measurement of vibration at the handle. Part 8: Polishers and rotary, orbital and random orbital sanders

Specifications subject to change without prior notice.

\*The values stated in the table are from laboratory testing in conformity with stated codes and standards and are not sufficient for risk evaluation. Values measured in a particular work place may be higher than the declared values. The actual exposure values and amount of risk or harm experienced to an individual is unique to each situation and depends upon the surrounding environment, the way in which the individual works, the particular material being worked, work station design as well as upon the exposure time and the physical condition of the user. SurfPrep™ cannot be held responsible for the consequences of using declared values instead of actual exposure values for any individual risk assessment.

Further occupational health and safety information can be obtained from the following websites:

<http://europe.osha.eu.int> (Europe)

<http://www.osha.gov> (USA)

## Work Stations

The tool is intended to be operated as a hand held tool. It is always recommended that the tool be used when standing on a solid floor. It can be in any position but before any such use, the operator must be in a secure position having a firm grip and footing and be aware that the sander can develop a torque reaction. See the section "Operating Instructions".

## Putting the Tool into Service

Use a clean lubricated air supply that will give a measured air pressure at the tool of 90 psig (6.2 bar) when the tool is running with the lever fully depressed. It is recommended to use an approved 3/8 in. (10 mm) x 25 ft (8 m) maximum length airline. It is recommended that the tool be connected to the air supply as shown in Figure 1.

Do not connect the tool to the airline system without incorporating an easy to reach and operate air shut off valve. The air supply should be lubricated. It is strongly recommended that an air filter, regulator and lubricator (FRL) be used as shown in Figure 1 as this will supply clean, lubricated air at the correct pressure to the tool. Details of such equipment can be obtained from your supplier. If such equipment is not used then the tool should be manually lubricated.

To manually lubricate the tool, disconnect the airline and put 2 to 3 drops of suitable pneumatic motor lubricating oil such as Fuji Kosan FK-20, Mobil ALMO 525 or Shell TORCULA® 32 into the hose end (inlet) of the machine. Reconnect tool to the air supply and run tool slowly for a few seconds to allow air to circulate the oil. If the tool is used frequently, lubricate it on a daily basis or lubricate it if the tool starts to slow or lose power.

It is recommended that the air pressure at the tool be 90 PSI (6.2 Bar) while the tool is running so the maximum RPM is not exceeded. The tool can be run at lower pressures but should never be run higher than 90 PSI (6.2 Bar). If run at lower pressure the performance of the tool is reduced.

## Operating Instructions

- 1) Read all instructions before using this tool. All operators must be fully trained in its use and aware of these safety rules. All service and repair must be carried out by trained personnel.
- 2) Make sure the tool is disconnected from the air supply. Select a suitable abrasive and secure it to the back-up pad. Be careful and center the abrasive on the back-up pad.
- 3) Always wear required safety equipment when using this tool.
- 4) When sanding always place the tool on the work then start the tool. Always remove the tool from the work before stopping. This will prevent gouging of the work due to excess speed of the abrasive.
- 5) Always remove the air supply to the sander before fitting, adjusting or removing the abrasive or back-up pad.
- 6) Always adopt a firm footing and/or position and be aware of torque reaction developed by the sander.
- 7) Use only correct spare parts.
- 8) Always ensure that the material to be sanded is firmly fixed to prevent its movement.
- 9) Check hose and fittings regularly for wear. Do not carry the tool by its hose; always be careful to prevent the tool from being started when carrying the tool with the air supply connected.

- 10) Dust can be highly combustible. Vacuum dust collection bag should be cleaned or replaced daily. Cleaning or replacing of bag also assures optimum performance.
- 11) Do not exceed maximum recommended air pressure. Use safety equipment as recommended.
- 12) The tool is not electrically insulated. Do not use where there is a possibility of coming into contact with live electricity, gas pipes, water pipes, etc. Check the area of operation before operation.
- 13) Take care to avoid entanglement with the moving parts of the tool with clothing, ties, hair, cleaning rags, etc. If entangled, it will cause the body to be pulled towards the work and moving parts of the machine and can be very dangerous.
- 14) Keep hands clear of the spinning pad during use.
- 15) If the tool appears to malfunction, remove from use immediately and arrange for service and repair.
- 16) Do not allow the tool to free speed without taking precautions to protect any persons or objects from the loss of the abrasive or pad.

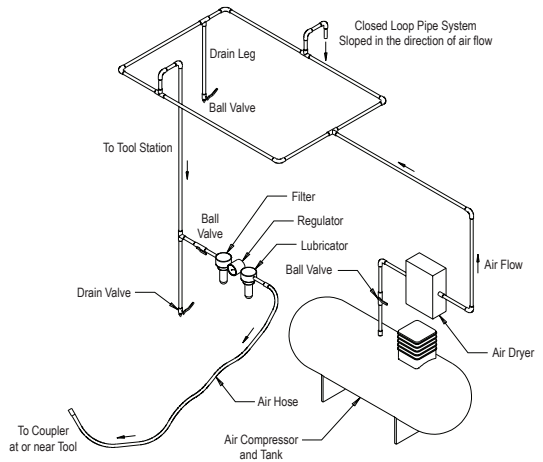

Figure 1



# SERVICE INSTRUCTIONS FOR 12,000 RPM 3 in. (77 mm) Light Weight RANDOM ORBITAL SANDERS

## Service Tools and Accessories

When an SurfPrep™ LP ROS needs to be serviced, we offer tool kits or individual tools to make the disassembly/assembly fast and easy. The Service Tools are highly recommended for use with the Overhaul Service Kit. NOTICE: To receive any expressed or implied warranty, tool must be repaired by an authorized SurfPrep™ Service Center. The following general service instructions provided are for use after completion of the warranty period.

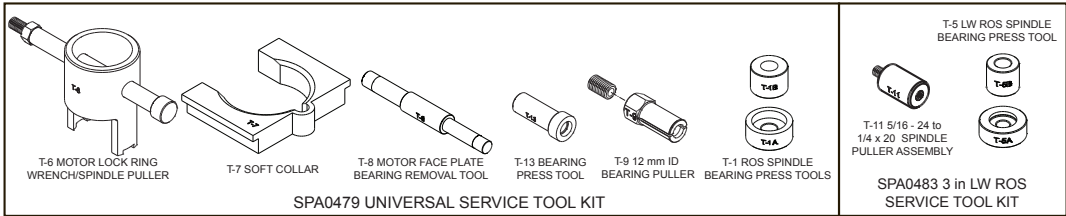

## Overhaul Service Kit

The SPA0398 Overhaul Service Kit contains all the replacement parts that naturally wear over time and a straightforward manual to make servicing an SurfPrep™ sander simple. Overhauling the Random Orbital Sander can be made even easier with the use of the above Service Tools. The Service Tools also reduce the chance of improper assembly.

SPA0398 Overhaul Service Kit Contents		
Part No.	Description	Qty.
SPA0040	External Retaining Ring	1
SPA0021	Bearing	1
SPA0042	O-Ring	1
SPA0010	Vanes	5
SPB0005	Rotor	1
SPA0041	Key	1
SPA0019	Bearing	1
SPA0162	Bearing	1
SPA0196	Spacer	1
SPA0161	Bearing	1
SPA0008	Valve Stem Assembly	1
SPA0043	O-Ring	1
SPA0039	Internal Retaining Ring	1
SPA0062	Bronze Muffler	1
SPA0068	Muffler	1
SPA0166	Muffler Housing	1
SPA0009	Valve Seat	1
SPA0007	Valve	1
SPA0014	Valve Spring	1

# Sander Spare Parts Kits

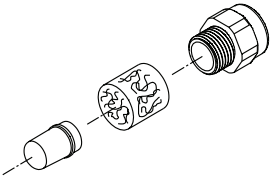

12,000 RPM Muffler Kit  
Reorder P/N SPA0096

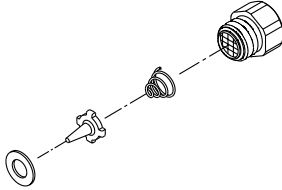

1/4-18 NPT Air Inlet Kit  
Reorder P/N SPA0431

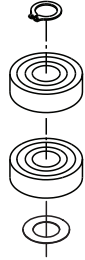

Endplate Bearing Kit  
Reorder P/N SPA0434

FOR 2.5mm ORBIT

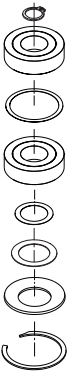

Spindle Bearing Kit  
Reorder P/N SPA0497

FOR 5.0mm ORBIT

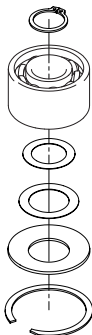

Spindle Bearing Kit  
Reorder P/N SPA2306

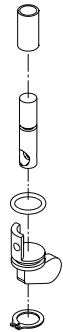

Speed Valve Kit  
Reorder P/N SPA0432

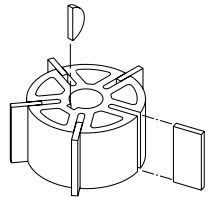

Rotor, Vanes and Key Kit  
Reorder P/N SPA0063

# 12,000 RPM 3 in. (77 mm) LW ROS Service Instructions

NOTICE: To receive any expressed or implied warranty, the tool must be repaired by an authorized Service Center. The 3 in. (77 mm) Light Weight Random Orbital Sander Service Instructions section provided is for use after completion of the warranty period.

## DISASSEMBLY INSTRUCTIONS

### Changing Grips:

1. The Grip has two "tabs" that wrap around the body of the sander under the inlet and exhaust. Use a small screwdriver to pick out one of the "tabs" of the Grip, then continue to go underneath the Grip with the screwdriver and pry the Grip off the sander. To install a new Grip, hold the Grip by the tabs making them face outward, align the Grip and slide it under the Throttle Lever then press the Grip down until it seats onto the top of the sander. Make sure the two "tabs" seat under the inlet and exhaust.

### Motor Disassembly:

1. Lightly secure the tool in a vise using the T-7 Service Colar or padded jaws. Use a 17 mm Pad Wrench to secure the Spindle and spin the Pad counter clock-wise off the spindle.
2. Remove the Lock Ring with the T-6 Motor Lock Ring Wrench/Spindle Puller Tool. The motor assembly can now be lifted out of the Housing. Remove the O-Ring from the Lock Ring.
3. Secure the motor assembly by clamping the Shaft Balancer in a padded jaw vise and remove the Retaining Ring from the end of the Shaft Balancer and the O-ring from the Cylinder.
4. Remove the Rear Endplate. This may require supporting the Rear Endplate with a bearing separator. Use a light press force to push the Shaft Balancer through the Bearing. Then remove the Cylinder, Vanes and the Rotor. Remove the Key from the Shaft Balancer. Support the Front Endplate with a bearing separator and use a light press force to push the Shaft Balancer through the bearing. It may be necessary to remove the Bearing with a bearing separator if it came out of the Front Endplate and stuck to the shaft of the Shaft Balancer.
5. Remove and discard Dust Shield from the Shaft Balancer.
6. Remove the Bearing(s) from the Endplates by using the T-8 Endplate Bearing Removal Tool to press out the Bearings.

### Shaft Balancer and Spindle Disassembly:

1. Grip the shaft end of the Shaft Balancer in a padded vise. With a thin screwdriver pick out the slotted end of the Retaining Ring and peel out.
2. Screw the female end of the T-11 5/16-24 to 1/4-20 Adapter into the male end of the Service Wrench. Screw the Service Wrench assembly into the Spindle Assembly until hand tight. Apply a gentle heat from a propane torch or hot air gun to the large end of the Shaft Balancer until it is about 212° F (100° C) to soften the adhesive. Do not over heat. Remove the Spindle Assembly by using the Slider to give sharp outward blows to the Spindle. Allow the parts to cool so they are safe to handle.
3. Remove the Retaining Ring from the Spindle Assembly. Use a small Bearing Separator to remove the Bearing, Spacer, Bearing, Shim, Dust shield and the Washer from the Spindle Assembly. Discard Dust Shield.

4. The AirSHIELD™ components are held in place by the light press fit of the Retainer. These components can be damaged during removal and may need to be replaced if removed. To remove the Retainer, use an O-ring pick or a #8 sheet metal screw to grip and pull out the Retainer. Remove the Valve and Filter from the bore in the Shaft Balancer. If the Retainer and Valve were not damaged, they can be reused. However, the Filter should be replaced on re-assembly.

### Housing Disassembly:

1. For Non-Vacuum (NV) and Central Vacuum (CV) machines follow steps A – B below (unless otherwise noted). For Self Generated Vacuum (SGV) machines disregard steps A – E and move onto Step G below.
  - A. Unscrew the Muffler Housing from the Housing. Remove the Bronze Muffler from the Muffler Housing (if applicable). Remove the Muffler from the Muffler Housing. For NV machines move onto B. For CV machines move onto C.
  - B. Remove the 3 in. (77 mm) Non-Vacuum Shroud. For NV machines move onto step 2.

### For Central Vacuum (CV) Exhaust machines:

- C. Remove the Screw, Washer and Nut.
- D. Remove the Ø ¾ in. (19 mm) SuperVAC™ CV Swivel Exhaust Assembly (Standard) or the Ø 1 in. (28 mm) SuperVAC™ CV Swivel Exhaust Assembly (Optional) from the 3 in. (77 mm) SuperVAC™ Shroud.
- E. Remove the 3 in. (77 mm) SuperVAC™ Shroud from the Housing. Move onto step 2.

### For Self Generated Vacuum (SGV) Exhaust machines:

- F. Unscrew the SGV Retainer with an 8 mm hex key.
- G. Remove the Ø 1 in. (28 mm) Hose SGV Swivel Exhaust Assembly (Standard) or Ø ¾ in. (19 mm) Hose SGV Swivel Exhaust Assembly (Optional) from the SuperVAC™ Adapter.
- H. Pull the SGV Retainer out of the bore of the Swivel Exhaust Assembly and remove the two O-Rings.
  - I. Remove the 3 in. (77 mm) SuperVAC™ Shroud from the Housing.
2. Place the Speed Control to the midway position and remove the Retaining Ring. NOTE: If the machine is one of the vacuum models, the vacuum exhaust assembly must be removed (See section 1 above, for removal) before the Retaining Ring can be removed with locking pliers. The Speed Control will now pull straight out. Remove the O-ring.
3. Unscrew the Inlet Bushing Assembly from the Housing. Remove the Spring, Valve, Valve Seat, Valve Stem and the O-ring from the Valve Stem.
4. Press out the Spring Pin from the Housing and remove the Lever.

## ASSEMBLY INSTRUCTIONS

NOTE: All assembly must be done with clean dry parts and all bearings are to be pressed in place by the correct tools and procedures as outlined by the bearing manufacturers.



### Housing Assembly:

1. Install Throttle Lever into Housing with Spring Pin.
  2. Lightly grease the O-Ring and place it on the Speed Control. Install the Valve Stem and O-ring (cleaned and lightly greased) and insert the Speed Control into Housing in the midway position. Install Retaining Ring.
- CAUTION: Make sure the Retaining Ring is completely snapped into groove in the Housing.
3. Install the Valve Seat, Valve and the Spring. Coat the threads of the Inlet Bushing Assembly with 1 or 2 drops of Loctite™ 222 or equivalent non-permanent pipe thread sealant. Screw the Inlet Bushing Assembly into the inlet port on the Housing. Torque to 60 in/lbs (6.77 Nm.)
  4. For NV and CV machines follow the steps A - C. For SGV machines follow the steps G - J.

### This section is for Central Vacuum (CV) and Non-Vacuum (NV) machines.

- A. Place a clean Muffler all-the-way into the chamber of the Muffler Housing. Press the Bronze Muffler into the bore of the Muffler Housing (if applicable).
- B. Screw the Muffler Housing assembly into the Housing until hand tight. Use a 21 mm socket/torque wrench combination to torque the Muffler Housing. Torque to 20 in/lbs (2.25 Nm). For NV machines move onto C. For CV machines move onto step D.
- C. Install the 3 in. (77 mm) Non-Vacuum Shroud onto the Housing by working the Shroud over and around the bottom of the Housing flanges. Make sure the line up slots on the Housing and tabs on the Shroud are engaged. Move onto the "Spindle Bearings, AirSHIELD™ and Shaft Balancer Assembly" Section.

### This section continued from Section I for Central Vacuum (CV) Exhaust machines:

- D. Install the 3 in. (77 mm) SuperVAC™ CV Shroud on to the Housing by working the shroud over and around the bottom of the Housing flanges. Make sure the line up slots on the Housing and tabs on the Shroud are engaged.
- E. Slide the inlet end of the  $\varnothing$  3/4 in. (19 mm) SuperVAC™ CV Swivel Exhaust Assembly (Standard) or the  $\varnothing$  1 in. (28 mm) SuperVAC™ CV Swivel Exhaust Assembly (Optional) into the exhaust port of the 3 in. (77 mm) SuperVAC™ CV Shroud until it hits the stop on the SuperVAC™ CV Swivel Exhaust Assembly. Make sure the key on the SuperVAC™ CV Swivel Exhaust Assembly bracket is aligned and engaged with the keyway on the Housing.
- F. Place the Washer over the Screw. Thread the screw into the mounting hole of the  $\varnothing$  3/4 in. (19 mm) SuperVAC™ CV Swivel Exhaust Assembly or  $\varnothing$  1 in. (28 mm) SuperVAC™ CV Swivel Exhaust Assembly (Optional) and Housing until the end of the screw is flush with the inside surface of the Housing. Place the Nut into the cavity of the Housing and thread the screw into the nut until tight. Move onto the "Spindle, AirSHIELD™ and Shaft Balancer Assembly" Section.

### For Self Generated Vacuum (SGV) Exhaust machines:

- G. Install the 3 in. (77 mm) SuperVAC™ Shroud onto the Housing by working the shroud over and around the bottom of the housing flanges. Make sure the line up slots on the Housing and tabs on the Shroud are engaged. Slide the SuperVAC™ SGV Exhaust Adapter Fitting into the

- exhaust of the 3 in. (77 mm) SuperVAC™ CV Shroud.
- H. Lightly grease two O-Rings and place them into the two grooves in the SGV Retainer.
  - I. Put the SGV Retainer into the mounting hole of the  $\varnothing$  1 in. (28 mm) Hose SGV Swivel Exhaust Assembly (Standard) or the  $\varnothing$  3/4 in. (19 mm) Hose SGV Swivel Exhaust Assembly (Optional).
  - J. Slide the Swivel Exhaust Assembly into the SuperVAC™ SGV Exhaust Adapter Fitting while at the same time inserting the SGV Retainer into the sander Housing exhaust port. Screw the SGV Retainer into the threaded exhaust port on the Housing with an 8 mm hex key. Torque to 45 in/lbs (5.08 Nm. ).

### Spindle Bearings, AirSHIELD™ and Shaft Balancer Assembly:

1. Place the T-5A Spindle Bearing Pressing Tool Base onto a flat, clean surface of a small hand press or equivalent with the spindle pocket facing upward. Place the Spindle into the spindle pocket with the shaft facing upwards.
2. Place the Washer on the Spindle shaft with the curve of the Washer facing out so that the outside diameter of the Washer will contact the outer diameter of the Bearing (one seal). Place the Dust Shield onto the Spindle shaft. Lay the Shim(Spacer) on the shoulder of the Spindle. Note: Be sure that the Dust Shield is past the shoulder where Shim(Spacer) rests. Place the Bearing on the Spindle with the seal side toward the Washer. NOTE: Make sure that both the inner and outer races of the Bearings are supported by the Bearing Press Tool when pressing them into place. Press the Bearing onto the shoulder of Spindle using the T-5B (T-1B)Spindle Bearing Pressing Tool Top as shown in Figure 2 (5).
3. For 2.5mm orbit machines: Place the Spacer over the Spindle shaft and onto the face of the Bearing making sure it is on center. Press the (no seals/shields) Bearing down using the T-5B Spindle Bearing Pressing Tool Top, being careful to make sure the Spacer is still centered on the vertical axis of the Spindle shaft and Bearing. See Figure 3. NOTE: When the Spindle Assembly is done correctly, the Bearings will rotate freely but not loosely and the Spacer can be moved but will not slide or move by gravity.
4. Secure the Retaining Ring onto the Spindle Assembly making sure it is completely snapped into the groove. Set the Spindle Assembly aside.
5. Take the Filter and center it on the small bore that the original filter was in before removal. With a small diameter screwdriver or flat end rod, press the Filter into the bore until it is flat in the bottom of the bore. Place the Valve into the bore so it is oriented correctly, then press the Retainer into the bore until it is flush with the bottom of the bearing bore.
6. Apply a pin head size drop of #271 Loctite® or equivalent to the outside diameter of each of the bearings on the Spindle Assembly. Spread the drop of bearing locker around both bearings until distributed evenly. CAUTION: Only a very small amount of bearing locker is needed to prevent rotation of the bearing OD. Any excess will make future removal difficult. Place the Spindle Assembly into the bore of the Shaft Balancer and secure with the Retaining Ring. CAUTION: Make sure that the Retaining Ring is completely snapped into the groove in the Shaft Balancer. Allow the adhesive to cure.

## For 2.5mm orbit Machine

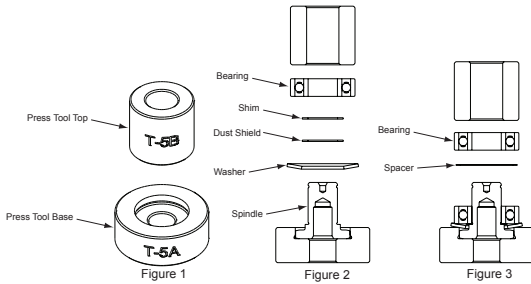

## For 5.0mm orbit Machine

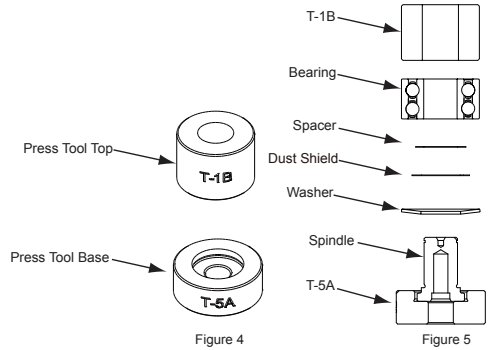

### Motor Assembly:

- Place the Dust Shield onto the shaft of the Shaft Balancer.
- Use the larger end of the T-13 Bearing Press Sleeve to Press the front Bearing (with 2 Shields) onto the shaft of the Shaft Balancer.
- Slide the Front Endplate with the bearing pocket facing down onto the Motor Shaft. Gently press the Front Endplate onto the front Bearing using the larger end of the T-13 Bearing Press Sleeve until the front Bearing is seated in the bearing pocket of the Front Endplate. **CAUTION:** Only press just enough to seat the bearing into the pocket. Over-pressing can damage the bearing.
- Place the Key into the groove on the Shaft Balancer. Place the Rotor onto the shaft of the Shaft Balancer, making sure that it is a tight slip fit.
- Oil the five Vanes with a quality pneumatic tool oil and place in the slots in the Rotor. Place the Cylinder Assembly over the Rotor with the shorter end of the Spring Pin engaging the blind hole in the Front Endplate. **NOTE:** The Spring Pin must project .060 in. (1.5 mm) above the flanged side of the Cylinder.
- Press fit the rear (2) Bearing (2 shields) into the Rear Endplate with the T-1B Bearing Press Tool. Make sure the T 1B Press Tool is centered on the O.D. of the outer race. Lightly press fit the Rear Endplate and Bearing Assembly over the Shaft Balancer using the small end of the T-13 Bearing Press Sleeve. The sleeve should press only the inner race of the bearing. **IMPORTANT:** The Rear Endplate and Bearing Assembly is pressed correctly when the Cylinder is squeezed just enough between the Endplates to stop it from moving freely under its own weight when the shaft is held horizontal, but be able to slide between the Endplates with a very light force. If pressed to tightly the motor will not run freely. If the pressed assembly is to loose, the motor will not turn freely after assembly in the Housing.
- Secure the assembly by placing the Retaining Ring in the groove of the Shaft Balancer. **CAUTION:** The Retaining Ring must be placed so that the middle and two ends of the hoop touch the Bearing first. Both raised center portions must be securely "snapped" into the groove in the Shaft Balancer by pushing on the curved portions with a small screwdriver.

- Carefully screw the Lock Ring into the Housing using the T-6 Motor Lock Ring Wrench. Torque to 60 in/lbs (6.77 Nm.) **NOTE:** A simple technique to assure first thread engagement is to turn the lock ring counter clockwise with the service tool while applying light pressure. You will hear and feel a click when the lead thread of the lock ring drops into the lead thread of the housing, then turn clockwise to tighten.
- Spin on a new Pad and hand tighten it using a 17 mm Pad Wrench.

### Testing:

Place 3 drops of quality pneumatic air tool oil directly into the motor inlet and connect to a 90 psig (6.2 bar) air supply. The tool should run between 9,500 RPM and 10,500 for 10,000 RPM machines or 11,500 and 12,500 RPM for 12,000 RPM machines when the air pressure is 90 psig (6.2 bar) at the inlet of the tool while the tool is running at free speed. This free speed will be about 500 RPM to 1,000 RPM less when a Vacuum or Hook Face Pad is used because of wind resistance. This will not affect performance when sanding.

\* Loctite® is a registered trademark of the Loctite Corp.

# Troubleshooting Guide

Symptom	Possible Cause	Solution
Low Power and/or Low Free Speed	Insufficient Air Pressure	Check air line pressure at the Inlet of the Sander while the tool is running at free speed. It must be 90 psig (6.2 Bar).
	Clogged Muffler(s)	See the "Housing Disassembly" section for Muffler removal. The Muffler can be back flushed with a clean, suitable cleaning solution until all contaminates and obstructions have been removed. If the Muffler can not be properly cleaned then replace it. Replace Muffler Insert (See the "Housing Assembly" Section).
	Plugged Inlet Screen	Clean the Inlet Screen with a clean, suitable cleaning solution. If Screen does not come clean replace it.
	One or more Worn or Broken Vanes	Install a complete set of new Vanes (all vanes must be replaced for proper operation). Coat all vanes with quality pneumatic tool oil. See "Motor Disassembly" and "Motor Assembly".
	Internal air leakage in the Motor Housing indicated by higher than normal air consumption and lower than normal speed.	Check for proper Motor alignment and Lock Ring engagement. Check for damaged O-Ring in Lock Ring groove. Remove Motor Assembly and Re-Install the Motor Assembly. See "Motor Disassembly" and "Motor Assembly".
	Motor Parts Worn	Overhaul Motor. Contact authorized Service Center.
	Worn or broken Spindle Bearings	Replace the worn or broken Bearings. See "Shaft Balancer and Spindle Disassembly" and "Spindle Bearings, AirSHIELD™ and Shaft Balancer Assembly".
Air leakage through the Speed Control and/or Valve Stem.	Dirty, broken or bent Valve Spring, Valve or Valve Seat.	Disassemble, inspect and replace worn or damaged parts. See Steps 2 and 3 in "Housing Disassembly" and Steps 2 and 3 in "Housing Assembly".
Vibration/Rough Operation	Incorrect Pad	Only use Pad Sizes and Weights designed for the machine.
	Addition of interface pad or other material	Only use abrasive and/or interface designed for the machine. Do not attach anything to the Sanders Pad face that was not specifically designed to be used with the Pad and Sander.
	Improper lubrication or buildup of foreign debris.	Disassemble the Sander and clean in a suitable cleaning solution. Assemble the Sander. (See "Service Manual")
	Worn or broken Rear or Front Motor Bearing(s)	Replace the worn or broken Bearings. See "Motor Disassembly" and "Motor Assembly".
	For vacuum machines it is possible to have too much vacuum while sanding on a flat surface causing the pad to stick to the sanding surface.	For SGV machines add extra washer(s) to the pad spindle to increase the gap between the pad and shroud. For CV machines reduce vacuum through the vacuum system and/or add extra washer(s) to the pad.



SurfPrep™ Tools  
571 BIRCH STREET LAKE ELSINORE, CA 92530  
Tel : 951-245-4200  
Fax: 951-245-4299